



(11) **EP 2 199 087 B1**

(12) **EUROPEAN PATENT SPECIFICATION**

(45) Date of publication and mention of the grant of the patent:
18.01.2012 Bulletin 2012/03

(51) Int Cl.:
B41J 3/01 (2006.01) B41J 11/00 (2006.01)

(21) Application number: **09014046.8**

(22) Date of filing: **10.11.2009**

(54) **Print enhancement of pixels to improve readability**

Druckverbesserung von Pixeln zur Verbesserung der Lesbarkeit

Amélioration d'impression de pixels pour améliorer la lisibilité

(84) Designated Contracting States:
AT BE BG CH CY CZ DE DK EE ES FI FR GB GR HR HU IE IS IT LI LT LU LV MC MK MT NL NO PL PT RO SE SI SK SM TR

(30) Priority: **18.12.2008 US 337792**

(43) Date of publication of application:
23.06.2010 Bulletin 2010/25

(73) Proprietor: **Pitney Bowes, Inc.**
Stamford, CT 06926-0700 (US)

(72) Inventors:
• **Auslander, Judith, D.**
Westport
Connecticut 06880 (US)

• **Quine, Douglas B.**
Bethel
Connecticut 06801 (US)

(74) Representative: **HOFFMANN EITLE**
Patent- und Rechtsanwälte
Arabellastraße 4
81925 München (DE)

(56) References cited:
EP-A1- 1 291 187 WO-A1-2008/133630
JP-A- 2004 291 401 US-A1- 2008 001 983

EP 2 199 087 B1

Note: Within nine months of the publication of the mention of the grant of the European patent in the European Patent Bulletin, any person may give notice to the European Patent Office of opposition to that patent, in accordance with the Implementing Regulations. Notice of opposition shall not be deemed to have been filed until the opposition fee has been paid. (Art. 99(1) European Patent Convention).

Description

[0001] The invention relates generally to the field of printing and more particularly to improving the readability of printed matter.

[0002] Printed matter needs to be printed with a high level of quality to ensure readability by automation equipment, especially when old technology readers require very high print contrast ratios to ensure readability. The problem is particularly evident when barcodes are automatically read by postal automation equipment and other barcode readers.

[0003] Barcodes have been used in a wide variety of applications as a source for information. Typically barcodes are used at a point-of-sale terminal in merchandising for pricing and inventory control. Barcodes are also used in controlling personnel access systems, mailing systems, and in manufacturing for work-in process and inventory control systems, etc. The barcodes themselves represent numbers or alphanumeric characters by series of adjacent stripes of various widths, (i.e. a width modulated universal product code), heights (i.e. a height modulated POSTNET barcode), or position (2D barcode).

[0004] An ordinary barcode is a set of binary numbers. It typically consists of black bars and white spaces. A wide black bar space may signify a one and a thin black bar or space may signify a zero. The binary numbers stand for decimal numbers or letters. There are several different kinds of barcodes. In each one, a number, letter or other character is formed by a pre-established number of bars and spaces.

[0005] Width modulated barcodes are "vertically redundant", meaning that the same information is repeated vertically. They are in fact a one-dimensional code. The heights of the bars can be truncated without any lose of information. A two-dimensional code stores information along the height as well as the length of the symbol. Thus, in the same area more information may be stored in a two dimensional barcode than in a one dimensional barcode.

[0006] Current technology printers may leave small unintended voids between pixels which prevent achievement of the highest print contrast and uniform coverage of which the ink dyes or pigments are theoretically capable of. Such unintended voids are caused by the nature of ink jet printing of placing small drops (1-50 pL) on rough surface of paper with "peaks and valleys" . The ink jet drops do not reach the paper surface in a uniform way and therefore cause to " graininess " as defined by the Standard ISO 13660, or non uniform print coverage especially on plain paper. Therefore the result is a degradation of the print quality of printed images. In comparison the mass thermal transfer printing achieves a uniform print coverage with the melt wax bridging the irregularities of the paper surface.

[0007] These characteristics affect the uniformity of the modules printed in the 2 D bar codes which might be interpreted as background by scanners. Barcodes, , are also very sensitive to ink in unwanted locations - the line of contact and the white spaces in barcodes must be preserved and readability can be severely impacted if ink is allowed to bleed into regions which are intended to be blank (print growth).

[0008] One of the problems of the prior art is that it is often difficult to automatically read printed information.

[0009] Another problem of the prior art is that it is often difficult to automatically read printed information that has a low print contrast ratio which is due to non optimal print coverage.

[0010] EP-A1-1 291 187 provides a method of optimized ink jet printing of barcodes. Inkjet printing of barcodes is enhanced by several methods. In a printhead having two staggered columns of nozzles, using only the even (or odd) column enhances resolution of a vertical barcode element. Filling interior portions of the barcode element with the odd (or even) column improves barcode appearance. Barcode swelling, due to ink migration after application, is reduced by use of a depletion matrix to lessen the quantity of ink applied. Application of the depletion matrix to the edges of the barcode elements resists swelling where resolution is most required. Where a printing mask is applied to the edges of the barcode elements, the edges may be printed only by one column of printhead nozzles, or only during one direction of printhead movement, or both. Alternately, removal of one or more pixels along the edge of a barcode element allows each barcode element to swell to the desired size.

[0011] This invention overcomes the disadvantages of the prior art by providing a method to improve barcode print image quality by printing the bar code ink from one printhead or trench and then applying the solvent from a second printhead on the first printed image in order to improve the printed area uniformity. The conditions of the 2 inks to be printed are the following : the first ink has to have a low percentage of colorant soluble in the post printed solvent and the solvent has to be able to wet the first print efficiently during the printing process. The invention utilizes a print head to cause localized improvement by applying a fluid that acts on prints generated by another print head.

[0012] The invention also prevents bleeding into unwanted areas where it could lower the quality of the printed material by utilizing the localized (targeted) print capabilities of print heads.

Fig. 1 illustrates in enlarged detail portions of code bars of an ideal one dimensional barcode;

Fig. 2 is a drawing of a two dimensional (2-d) barcode;

Fig. 3 illustrates in enlarged detail an idealized black rectangle 64 of Fig. 2;

Fig. 4 illustrates in enlarged detail a barcode data element (black rectangle 64) of Fig. 2 that comprises a matrix of 5 by 5 printed pixels;

Fig. 5 illustrates in enlarged detail a barcode data element (black rectangle 64) of Fig. 2 that comprises a matrix of 5 by 5 printed pixels 66, showing pixels 66 in the enhanced coverage area 68 of rectangle 64;

Fig. 6 illustrates in enlarged detail a barcode data element (64) of Fig. 5 that that formed an almost solid black area 69 after the facilitator evaporated;

5 Fig. 7 illustrates a large black rectangle 70 that comprises a matrix of 10 by 10 printed pixels 66, showing the pixel trimmed facilitator print area 71 with a subset rectangular reduced print area 72 for reduced facilitator print;

Fig. 8 illustrates in enlarged detail a black rectangle 70 of Fig. 7 that that formed an almost solid black area 79 without pooling after the facilitator evaporates;

Fig. 9 is a process flow diagram of the printing of rectangle 64 of Fig. 6;

10 Fig. 10 is a drawing of the apparatus of this invention showing two print heads (ink and facilitator) that print the enhanced barcode 60;

Fig. 11 is a drawing of the apparatus of this invention showing two print heads (ink and facilitator) as they move across the paper 204 leaving a trail of printed enhanced barcode data elements; and

15 **[0013]** Referring now to the drawings in detail, and more particularly to Fig. 1, the reference character 11 represents an enlarged detail portion of a width modulated barcode. Barcode 11 contains bars 12, 13 and 14 and spaces 15, 16 and 17. Bar 12 is three pixels wide, bar 13 is two pixels wide, and bar 14 is one pixel wide. Bar 12 represents a unique number (i.e., three), bar 13 represents a unique number (i.e., two), and bar 14 represents a unique number (i.e., one). Spaces 15, 16 and 17 are one unit wide.

20 **[0014]** Fig. 2 is a drawing of a two dimensional (2-d) barcode 60. Barcode 60 includes: a start pattern 61, that informs a scanner (not shown) when to begin reading data; a data portion 62; and a stop pattern 63, that informs a scanner when to stop reading data. Data portion 62 comprises printed barcode data elements (rectangles) 64 and non printed barcode data elements (spaces) 65. The coded information represented by data portion 62 is contained in the relative positions of the printed (64) and non printed (65) barcode data elements that are scanned.

25 **[0015]** Fig. 3 illustrates in enlarged detail an idealized black rectangle 64 of Fig. 2.

[0016] Fig. 4 illustrates in enlarged detail a black rectangle 64 of Fig. 2 that comprises a matrix of 5 by 5 printed pixels 66. The printed pixels 66 have unintended voids 67 between them. The print contrast within the printed area of rectangle 64 is diluted by the unintended voids 67 or white space between pixels 66 resulting in an average lower optical density and therefore lowered contrast ratio even in the presence of an "ideal" 100% black ink.

30 **[0017]** Fig. 5 illustrates in enlarged detail a black rectangle 64 of Fig. 2 that comprise a matrix of 5 by 5 printed pixels 66, including nine pixels 66 in the enhanced coverage area 68 of rectangle 64. A facilitator (e.g. water) of the black ink that prints pixels 66 may be applied to the enhanced coverage area 68 (before or after printing). The pixel trimmed area 68 has been defined as the area remaining after trimming one row of pixels 66 off the top and bottom of the original rectangle 64 and one column off the left and right of the original rectangle 64. This prevents any unwanted bleeding of the image outside the intended boundaries of rectangle 64. This facilitator causes enhanced coverage of the pixels 66 in area 68 resulting in the image displayed in Fig. 6 after the ink dries. Any number of pixels may be trimmed in different applications (more may be trimmed at higher print resolutions). The pixel trimming may also be different in different directions. For instance, the manufacturing process of paper results in a "grain" of preferred fiber orientation. Ink may show unintended bleed differently along the grain of the paper than across the grain of the paper. Therefore it may be desirable for the print area 68 for facilitator application to be trimmed more from the original rectangle 64 along the long axis (with the grain) of the paper than across the grain. A first print head may be used to apply a facilitator like water. The first print head may also be an existing print cartridge containing both ink and facilitator which is utilized for this function. And a second print head, like Xerox Y100 produced by Xerox Corporation, 100 South Clinton Avenue, Rochester, NY 14644, U.S.A. may be used to print pixels 66 with a black ink.

35 **[0018]** Fig. 6 illustrates in enlarged detail a black rectangle 64 of Fig. 5 that formed an almost solid black area 69 after the ink dried. The print quality and readability of rectangle 64 is improved because rectangle 64 is practically a solid black mass that contains no white areas or voids. The enhanced coverage printed area has been homogenized (resulting in a more uniform optical density within the area) by adding the facilitator.

40 **[0019]** The present invention recognizes that parameters may be set to define the number of pixels to trim (possibly different values in different axes or different values for the lead and trailing sides of print areas) from the outer perimeter of a rectangle to ensure that the facilitator induced enhanced coverage of individual pixels 66 does not cause unintended bleed beyond the boundaries of printed rectangles 64. Figure 7 illustrates a print rectangle 70 from which two pixel columns (75) have been stripped from the right and left side (as well as pixel rows from the top and bottom) to define the reduced print area rectangle 71.

45 **[0020]** A further embodiment of this invention recognizes that when large solid rectangles (70) are printed on paper, there may be a central area (rectangle 72) in which ink tends to pool because the paper fibers are saturated with ink. Therefore, a second parameter may be defined which further limits the maximum solid rectangular area (71) over which facilitator will be applied. In Figure 7, while facilitator will be applied to the rectangular area 71, it will be applied in reduced

volume (e.g. 50%) in the inner rectangular reduced print area (72). Considering a cross section of this printed area therefore, we observe that the entire rectangle (70) has been printed with black ink. The facilitator raster print area has been defined as the original print area (70) less a two pixel boundary (75) on the right, left, top, and bottom resulting in a facilitator print area of rectangle 71. We have further defined an inner rectangular reduced print area (72) in which the facilitator application will be at a reduced rate of 50%. This rectangle could be computed as the facilitator print area less a defined number of border pixels (76) resulting in 4 pixels (77) trimmed from the original rectangle height (and 4 from the width) to which the reduced facilitator volume is applied to prevent ink pooling.

[0021] Fig. 8 shows the result of this process in which region 79 provides enhanced coverage of the print area with homogenized optical density within the bounds of the rectangle 70.

[0022] Fig. 9 is a process flow diagram of the printing of rectangle 64 of Fig. 6. The process begins in step 100 to activate in situ image enhancement. Then in step 101 the image is rasterized for the printing of rectangle 64 with black ink. The process of image rasterization for printing is well known in the industry. Rasterization means that the original two dimensional image is converted into a series of strips (rows) by the computer. For each potential print pixel a determination is made as to whether it should be printed in black or left unprinted (white). This raster data is then used to drive print commands or signals to the print head as it scans across the corresponding points on the unprinted paper. Now in step 102 the present invention takes the existing rasterized image and trims one (or more as desired) pixel from all contiguous solid print areas to generate the corresponding enhanced print area 68 facilitator print raster data. Pixels are not trimmed from rectangles 64 which are completely surrounded (within the contiguous print area) by other printed rectangles 64. In step 103 the media is passed through the printer. As it passes through, in step 104 the first (facilitator) print head prints (overlays) facilitator on all subset areas 68 within rectangles 64. Then in step 105 the second (ink) print head of the printer prints pixels 66 in all rectangles 64 as directed by the black ink raster data. Now in step 106 the facilitator and ink produce an enhanced coverage solid black area 69 that contains virtually no white areas or voids within the boundaries of rectangles 64.

[0023] Fig. 10 is a drawing of the apparatus of this invention showing two print heads (ink 201 and facilitator 202) that print the enhanced barcode 60. Print head controller 200 is coupled to print head 201 that ejects a black ink and controller 200 is coupled to print head 202 that ejects the facilitator for the aforementioned black ink. Controller 200 causes ink drops from print head 201 and facilitator from ink jet 202 to fall on paper 204 that moves in direction A. Ink jets 201 and 202 move in direction B. Controller 200 will cause print heads 201 and 202 to print bar code 60.

[0024] It would be obvious to one skilled in the art that controller 200 may be used to control various print heads that eject colored inks so that bar code 60 may be a bar code that has multiple colors. Bidirectional print heads may utilize dual facilitator heads (either side) or ink which remain unfixed long enough for the facilitator to be effective when deposited after the ink is printed.

[0025] Figure 11 illustrates the black and facilitator print heads (201, 202) as they progress across the paper (204) in direction B printing a strip of the rasterized barcode (60). Printed material is visible to the left of the print heads while the paper remains white in advance of the print operation to the right. When the print strip is complete, the paper will advance the height of a print strip, the print head will reset to the left position, and the print operation can repeat. The present invention recognizes that columns of pixels are printed simultaneously across the face of the print head as it advances across the paper but that pixels in subsequent strips will be printed with a significant latency. For this reason, under circumstances of fast drying and rapidly setting inks, it may be desirable to operate the pixel stripping algorithms only within the confines of each printing swath rather than across the entire rasterized image. In this manner the facilitator may enhance coverage of the inks before they set.

[0026] The extraordinary diversity of ink vendors, ink formulations, printers, and paper types make it impractical to define specific ink formulations for use in the present invention. It is, however, possible to provide specific guidelines for their determination. First, each ink has a material, solvent, or fluid ("facilitator") which facilitates the enhanced coverage of ink into nearby areas. If this facilitator is applied when the ink is printed as described in this application then the ink will be better able to spread into the unwanted voids 67 and enhance coverage.

[0027] The application describes the concept of taking the area to be printed and pixel trimming the dimensions of that area for application of the facilitator to prevent unintended bleed of the ink. A straightforward calibration process may be utilized to determine the desired facilitator load and pixel trimming of the print area for facilitator application. A monochrome black dot pattern, as presented in the application figures, may be printed and the unintended voids between pixels observed as well as the quality of test barcodes. Test patterns (A- Z) allow for a progressive series of dot or barcode tests in which the quantity of facilitator and number of pixels trimmed is varied:

Table 1: Matrix Describing Print Quality Test Barcodes

Pixels Trimmed		%	Maximum	Facilitator	
	0%	25%	50%	75%	100%

EP 2 199 087 B1

(continued)

Pixels Trimmed		%	Maximum	Facilitator	
0	A	B	C	D	E
1	F	G	H	I	J
2	K	L	M	N	O
5	P	Q	S	T	U
10	V	W	X	Y	Z

[0028] The control test cases "A, F, K, P, and V" correspond to the instances in which no facilitator is applied (and therefore the trimming of the pixels is moot). At the opposite extreme, test cases in the final column represent instances in which the maximum facilitator is applied. Comparison of case "E" (no pixels trimmed) to cases with progressively greater numbers of pixels trimmed ("J, O, U, Z") will reveal the point at which the enhanced coverage extends beyond the boundaries of the intended pattern and therefore is causing unwanted image distortion. This test pattern would easily fit on a single sheet of paper and therefore the test print is accomplished quickly. Selection of the "best" pattern in which black and white pixels are of equal size could be done by visual inspection (as alignment patterns are done on many printers today) or through automation. Test cases may also be included to identify the effects of paper grain and allow setting of different pixel trimming parameters in the horizontal and vertical axes. An automated solution would be to utilize a barcode reader / verifier to read each of the printed barcodes and identify the point at which the read rates and quality are highest.

[0029] Since print media differ considerably in porosity (capacity for unintended ink bleed), different settings would be expected to be required for blotting paper and plastic transparency film. Vendors might choose to pretest and calibrate their inks (they know what inks they sell with particular printer models) and incorporate the settings into the control systems or printer drivers for their printers. Printers that sense the paper media could then utilize the media types with the corresponding facilitator strength and pixel trimming parameters. Since paper grain is typically aligned with the long axis of the paper, printers could adapt pixel trimming algorithms accordingly based upon the landscape (horizontal) or portrait (vertical) orientation of the paper.

[0030] Some print heads may have the ability to deliver varying quantities of ink (underdrive or overdrive) resulting in reduced or enlarged pixels as described in other applications by Check and Sansone in U.S. Patent Number 4,386,272 assigned to Pitney Bowes Inc. In such instances, the quantities of black ink delivered within regions 68 or 71 may be deliberately increased to produce enlarged pixels and the volumes of ink delivered to pixels within regions 72 may be reduced to produce reduced pixels. Dithering of pixels (deliberate omissions of pixels within a large region to reduce the overall intensity of the print while maintaining image integrity) may also be used to reduce unwanted pooling of ink due to saturation in large print areas 71.

[0031] The above specification describes a new and improved method for improving the readability of printed matter. It has been described with reference to black ink on white paper. It is realized that the above description may indicate to those skilled in the art additional ways in which the principles of this invention may be used without departing from the scope thereof including the use of any ink colors with the corresponding facilitators to allow them to enhance coverage and provide a better quality of print and the use of bidirectional printers. It is, therefore, intended that this invention be limited only by the scope of the appended claims.

Claims

1. A method for forming bars of a barcode (11), said method comprising the steps of:

printing (103) pixels (66) on a medium (204) with an ink; and
applying (104) a substance which facilitates the spread of the printed pixels (66) on the medium (204),
wherein the substance which facilitates the spread of pixels (66) on the medium is applied before or after the
pixels are printed.

2. The method claimed in any preceding claim, wherein the substance which facilitates the spread of pixels (66) is a solvent of the ink.

3. The method claimed in any preceding claim, wherein the substance which facilitates the spread of pixels is an

existing ink.

4. The method claimed in any preceding claim, wherein the substance which facilitates the spread of pixels are multiple inks from multiple print heads (201, 202).

5

5. The method claimed in any preceding claim, wherein the ink is applied in excess to cause growth of pixels into adjacent space on the medium.

10

6. The method claimed in any preceding claim, wherein the substance which facilitates the spread of pixels (66) on a medium (204) is applied to a subset of the pixels on the medium (204).

15

7. The method claimed in claim 6, wherein the substance which facilitates the spread of pixels (66) on a medium (204) is applied to a subset of the pixels (66) on the medium (204) which is determined by reducing the horizontal dimension of the solid pixel print areas by M pixels.

8. The method claimed in claim 6, wherein the substance which facilitates the spread of pixels (66) on a medium is applied to a subset of the pixels (66) on the medium which is determined by reducing the vertical dimension of the solid pixel print areas by N pixels.

20

9. The method claimed in claim 6, wherein the subset of the pixels on the medium for application of substance is determined during the rasterization (101) of the image by trimming (102) the boundaries of the solid print areas by N pixels.

25

10. The method claimed in claim 9, wherein:

the subset of the pixels on the medium for application of substance is determined during the rasterization (101) of the image;
information is included regarding the allocation of print data to separate print head (201, 202) passes; and
boundaries of the solid print areas within print head passes are trimmed (102) by N pixels.

30

11. The method claimed in claim 9, wherein:

the subset of the pixels on the medium for application of substance is determined during the rasterization (101) of the image;
information is included regarding the extent of the intended solid area; and
the volume of the substance to be applied in the center of a large overprint area is reduced to prevent pooling.

35

12. The method claimed in any preceding claim, wherein the ink printed has a portion of a colorant soluble in a solvent applied after printing.

40

Patentansprüche

1. Ein Verfahren zum Bilden von Strichen eines Strichcodes (11), wobei das Verfahren die Schritte umfasst:

45

Drucken (103) von Pixeln (66) auf ein Medium (204) mit einer Tinte; und
Aufbringen (104) einer Substanz, die die Ausbreitung der gedruckten Pixel (66) auf dem Medium (204) fördert, wobei die Substanz, die die Ausbreitung der Pixel (66) auf dem Medium fördert, aufgebracht wird vor oder nachdem die Pixel gedruckt werden.

50

2. Das in einem vorhergehenden Anspruch beanspruchte Verfahren, wobei die Substanz, die die Ausbreitung der Pixel (66) fördert, ein Lösemittel der Tinte ist.

55

3. Das in einem vorhergehenden Anspruch beanspruchte Verfahren, wobei die Substanz, die die Ausbreitung der Pixel fördert, eine existierende Tinte ist.

4. Das in einem vorhergehenden Anspruch beanspruchte Verfahren, wobei die Substanz, die die Ausbreitung der Pixel fördert, mehrere Tinten aus mehreren Druckköpfen (201, 202) sind.

5. Das in einem vorhergehenden Anspruch beanspruchte Verfahren, wobei die Tinte darüber hinaus aufgebracht wird, um Wachstum von Pixeln in den angrenzenden Raum auf dem Mediums zu veranlassen.

5 6. Das in einem vorhergehenden Anspruch beanspruchte Verfahren, wobei die Substanz, die die Ausbreitung von Pixeln (66) auf einem Medium (204) fördert, auf eine Teilmenge der Pixel auf dem Medium (204) aufgebracht wird.

7. Das in Anspruch 6 beanspruchte Verfahren, wobei die Substanz, die die Ausbreitung der Pixel (66) auf einem Medium (204) fördert, auf eine Teilmenge der Pixel (66) auf dem Medium (204) aufgebracht wird, die bestimmt wird durch Reduzieren der horizontalen Dimension der Festpixel-Druckflächen um M Pixel.

10 8. Das in Anspruch 6 beanspruchte Verfahren, wobei die Substanz, die die Ausbreitung der Pixel (66) auf einem Medium fördert, auf eine Teilmenge der Pixel (66) auf dem Medium aufgebracht wird, die bestimmt wird durch Reduzieren der vertikalen Dimension der Festpixel-Druckflächen um N Pixel.

15 9. Das in Anspruch 6 beanspruchte Verfahren, wobei die Teilmenge der Pixel auf dem Medium zum Aufbringen der Substanz bestimmt wird während der Rasterung (101) des Bildes durch Abschneiden (102) der Begrenzungen der Festdruckflächen durch N Pixel.

20 10. Das in Anspruch 9 beanspruchte Verfahren, wobei:

die Teilmenge der Pixel auf dem Medium zum Aufbringen der Substanz während der Rasterung (101) des Bildes bestimmt wird;
Information betreffend die Zuweisung von Druckdaten an separate Druckkopf- (201, 202) Verarbeitungsschritte beinhaltet ist; und Grenzen der Festdruckflächen innerhalb von Druckkopf-Verarbeitungsschritten um N Pixel abgeschnitten (102) werden.

25 11. Das in Anspruch 9 beanspruchte Verfahren, wobei:

30 die Teilmenge der Pixel auf dem Medium zum Aufbringen der Substanz während der Rasterung (101) des Bildes bestimmt wird;
Information betreffend das Ausmaß der beabsichtigten Festfläche beinhaltet ist; und die Menge der Substanz, die im Zentrum einer großen Überdruckfläche aufzubringen ist, reduziert wird, um Poolbildung zu reduzieren.

35 12. Das in einem vorhergehenden Anspruch beanspruchte Verfahren, wobei die gedruckte Tinte ein Teil eines Farbmittels aufweist, das in einem nach dem Druck aufgebracht Lösungsmittel lösbar ist.

40 Revendications

1. Procédé de formation de barres d'un code à barres (11), ledit procédé comprenant les étapes consistant à :

45 imprimer (103) des pixels (66) sur un support (204) au moyen d'une encre ; et
appliquer (104) une substance qui facilite l'étalement des pixels imprimés (66) sur le support (204),
la substance qui facilite l'étalement des pixels (66) sur le support étant appliquée avant ou après l'impression des pixels.

50 2. Procédé selon l'une quelconque des revendications précédentes, dans lequel la substance qui facilite l'étalement des pixels (66) est un solvant de l'encre.

3. Procédé selon l'une quelconque des revendications précédentes, dans lequel la substance qui facilite l'étalement des pixels est une encre existante.

55 4. Procédé selon l'une quelconque des revendications précédentes, dans lequel la substance qui facilite l'étalement des pixels consiste en des encres multiples provenant de multiples têtes d'injection (201, 202).

5. Procédé selon l'une quelconque des revendications précédentes, dans lequel l'encre est appliquée en excès de façon à provoquer un développement des pixels dans un espace adjacent sur le support.

EP 2 199 087 B1

6. Procédé selon l'une quelconque des revendications précédentes, dans lequel la substance qui facilite l'étalement des pixels (66) sur un support (204) est appliquée à un sous-ensemble des pixels sur le support (204).

5 7. Procédé selon la revendication 6, dans lequel la substance qui facilite l'étalement des pixels (66) sur un support (204) est appliquée à un sous-ensemble des pixels (66) sur le support (204) qui est déterminé en réduisant la dimension horizontale des zones d'impression de pixels pleines de M pixels.

10 8. Procédé selon la revendication 6, dans lequel la substance qui facilite l'étalement des pixels (66) sur un support est appliquée à un sous-ensemble des pixels (66) sur le support qui est déterminé en réduisant la dimension verticale des zones d'impression de pixels pleines de N pixels.

15 9. Procédé selon la revendication 6, dans lequel le sous-ensemble des pixels sur le support pour application de la substance est déterminé au cours de la rasterisation (101) de l'image en rognant (102) les limites des zones d'impression de pixels pleines de N pixels.

10. Procédé selon la revendication 9, dans lequel :

le sous-ensemble des pixels sur le support pour application de la substance est déterminé au cours de la rasterisation (101) de l'image ;

20 des informations sont incluses ayant trait à l'affectation de données à imprimer à des passages distincts de la tête d'impression (201, 202) ; et

les limites des zones d'impression pleines au sein des passages de la tête d'impression sont rognées (102) de N pixels.

25 11. Procédé selon la revendication 9, dans lequel :

le sous-ensemble des pixels sur le support pour application de la substance est déterminé au cours de la rasterisation (101) de l'image ;

30 des informations sont incluses ayant trait à l'étendue de la zone pleine envisagée ; et

le volume de la substance à appliquer au centre d'une grande zone de surimpression est réduit de façon à éviter une concentration.

35 12. Procédé selon l'une quelconque des revendications précédentes, dans lequel l'encre imprimée renferme une partie d'un colorant soluble dans un solvant appliqué après impression.

40

45

50

55

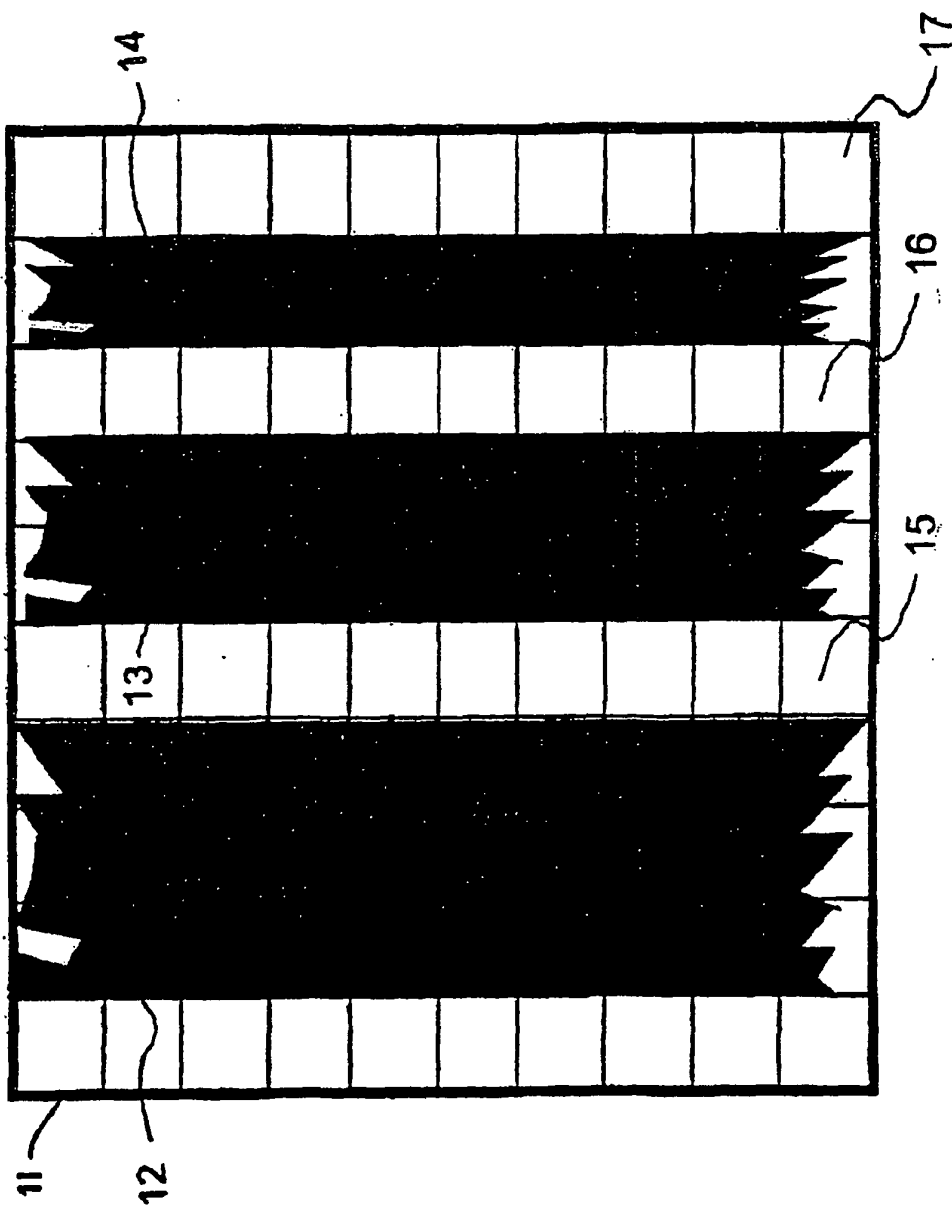

FIG. 1

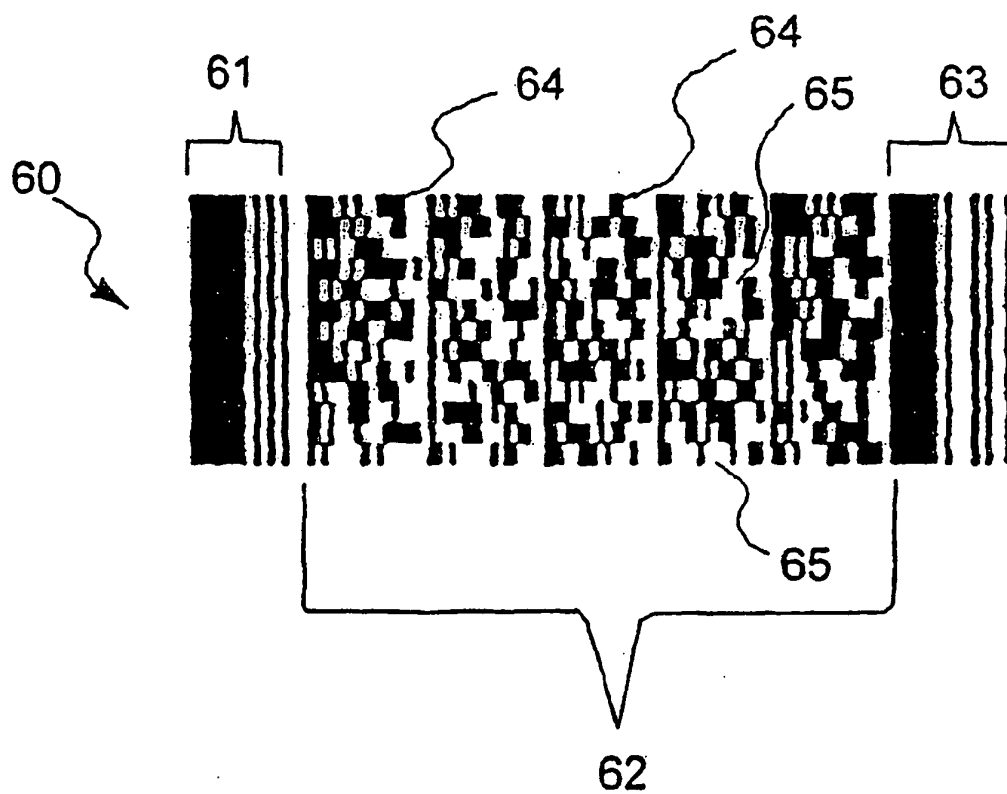

FIG. 2

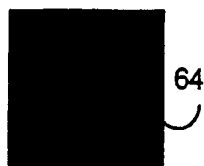

FIG. 3

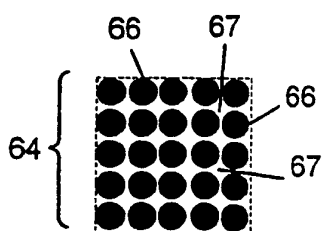

FIG. 4

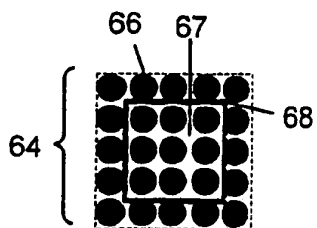

FIG. 5



FIG. 6

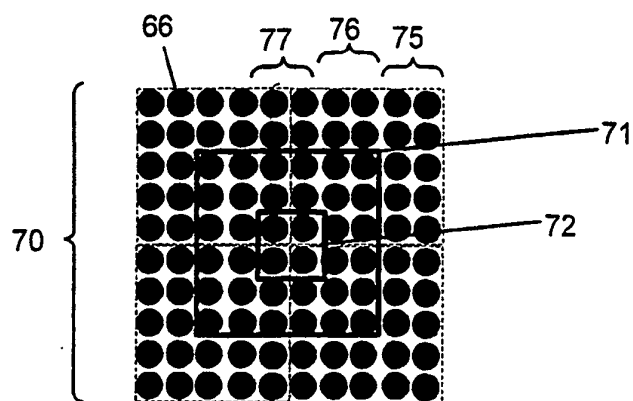

FIG. 7



FIG. 8

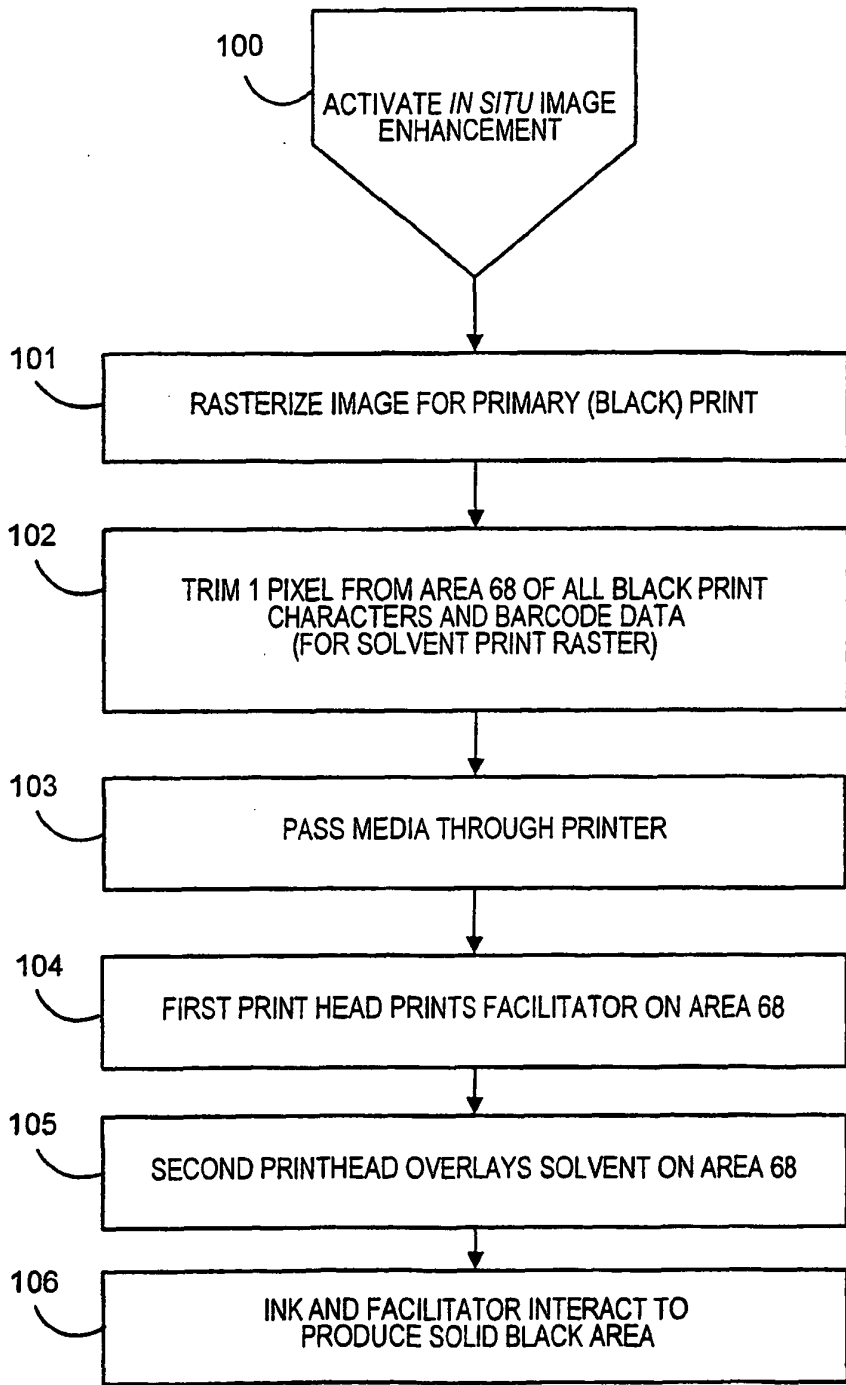

FIG. 9

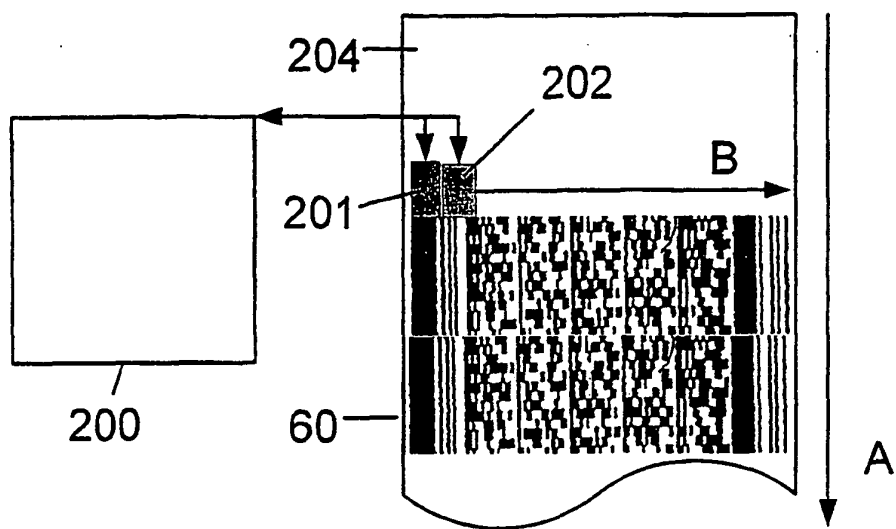

FIG. 10

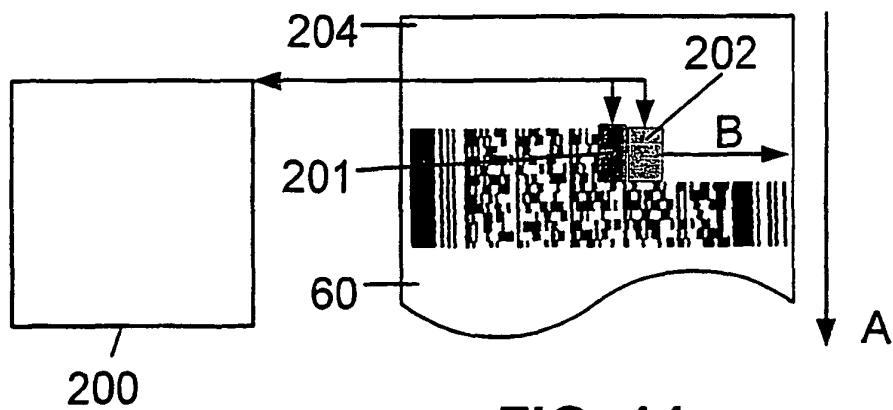

FIG. 11

REFERENCES CITED IN THE DESCRIPTION

This list of references cited by the applicant is for the reader's convenience only. It does not form part of the European patent document. Even though great care has been taken in compiling the references, errors or omissions cannot be excluded and the EPO disclaims all liability in this regard.

Patent documents cited in the description

- EP 1291187 A1 [0010]
- US 4386272 A [0030]